

Rozmery v mm; Maße in mm

Heat C 2g L 80.51.31.01(21)

245 kg

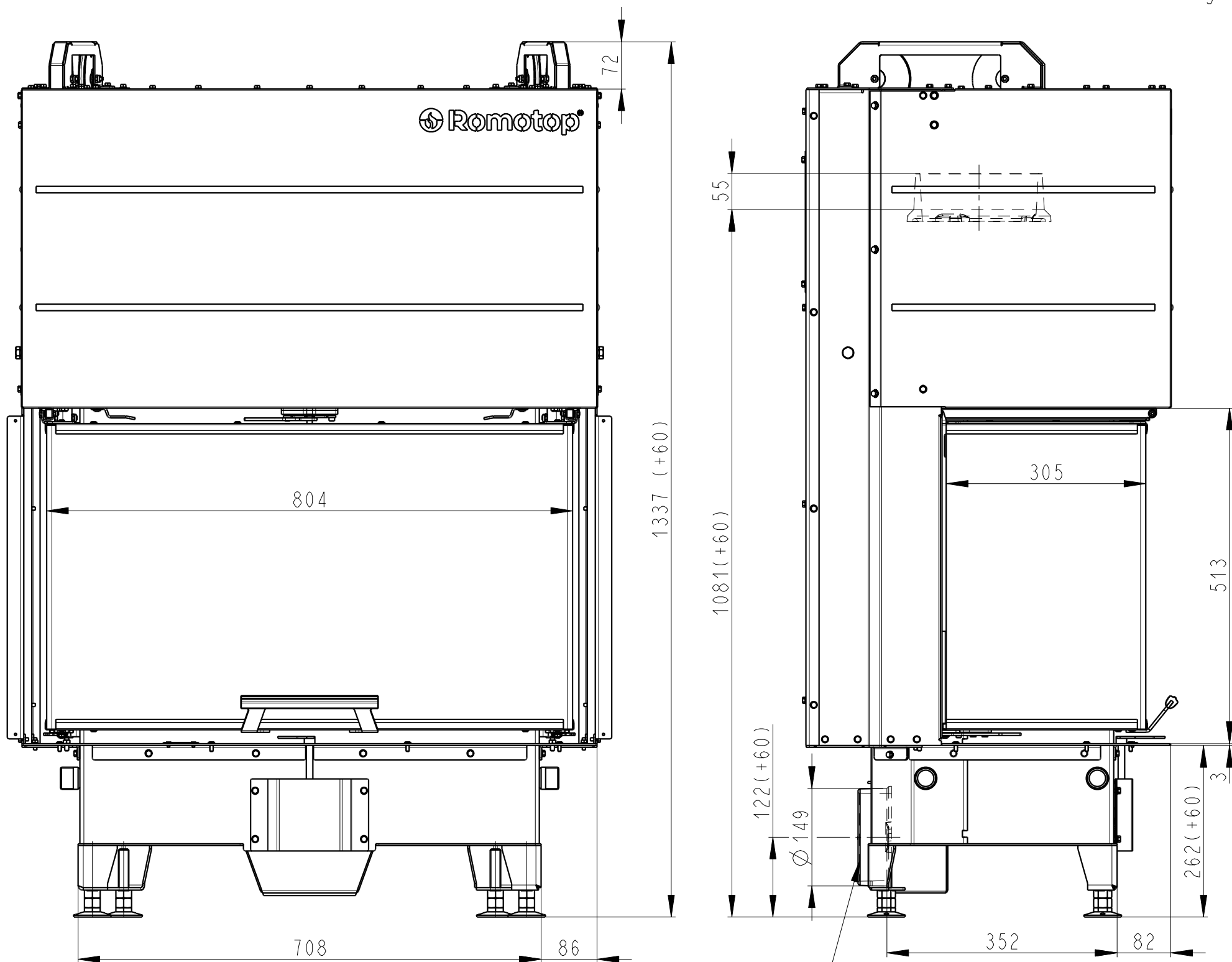

Centralni privod vzduchu  
Central air inlet  
Zentralluftzufuhr

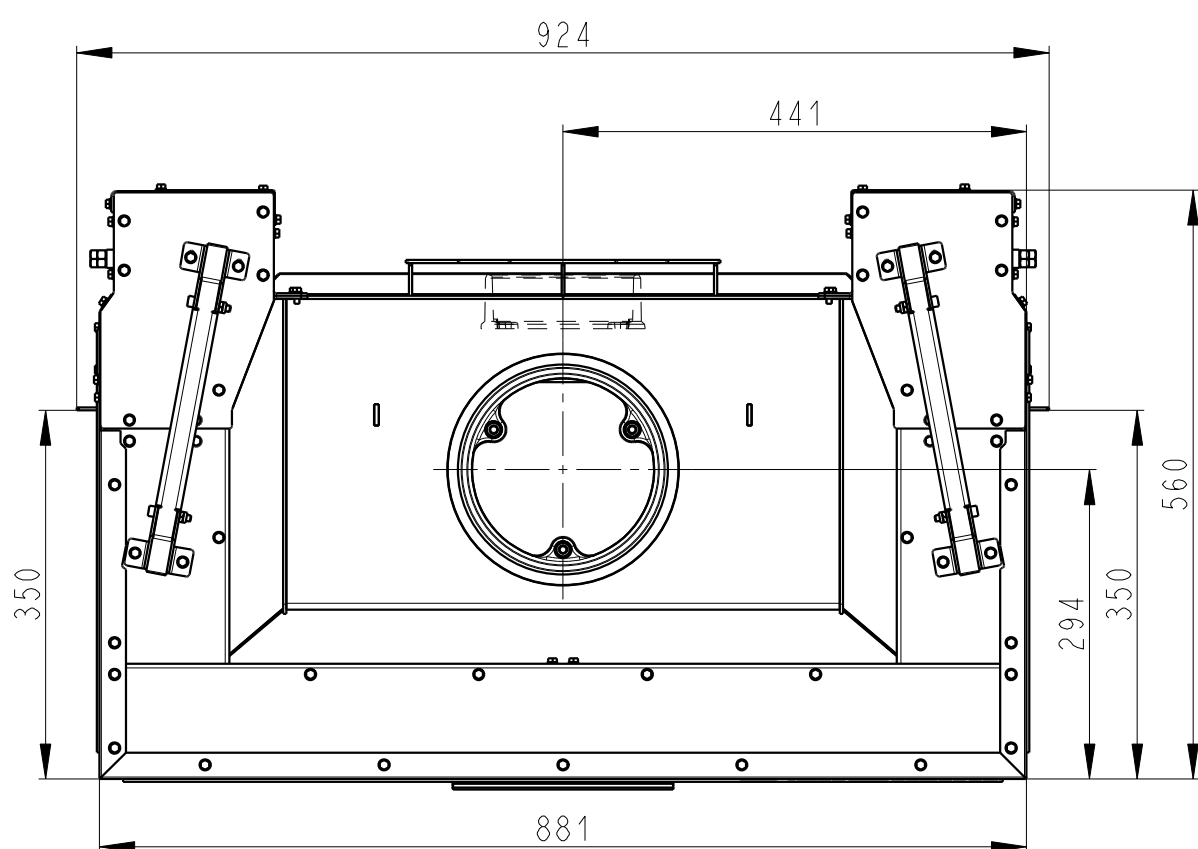

Primarni a sekundarni vzduch  
Primärluft und Sekundärluft  
Primary and secondary air

